

- 4 INPUTS WITH 4 TRACK AND STEREO OUTPUTS
- STEREO GRAPHIC EQUALIZER
- HIGH IMPEDANCE 1/4" PHONE-TYPE MICROPHONE INPUTS
- TWO-BAND EQUALIZATION ON EACH INPUT
- PEAK RANGING LED TO INDICATE AN OVERLOAD CONDITION ON EACH INPUT
- PEAK READING LED OUTPUT LEVEL INDICATORS FOR MASTER SECTION
- STRAIGHTLINE MONITOR LEVEL FADER

The AMR™ 42 mixer features four inputs and a stereo output. This quality mixer has been specifically designed and optimized to perform the processes of multi-track recording with ease and efficiency. The AMR 42 incorporates many operational features that are normally found on larger mixing consoles. As you become familiar with the operation of the AMR 42 you will grow to appreciate the attention to detail that makes this an exceptional mixer.

Each input channel features a high impedance ¼" phone-type microphone input, mic/line tape switching, tape input, tape output, mic/line input, input gain control, two-band (high and low frequency) equalization, auxiliary send, linear level control, pan

pot, and a peak-reading LED to indicate an overload condition on a specific input. The master section of the mixer features a stereo graphic equalizer (operated by a single set of slide controls) which allows the user to equalize both the left and right outputs during the final mixdown procedure. The external power supply contributes to the low noise of the AMR 42, thereby increasing its ability to make excellent recordings.

For you to become more familiar with the features of the AMR 42, the following paragraphs will highlight the features and operation of the entire mixer.

Mic/Line Input: This input is an unbalanced ¼" phone-type input for connection of high impedance (high Z) signals from microphones or line level signals from tape recorders, electronic keyboards, drum machines, etc. The mic/line input has the ability to accommodate a wide range of input signals with the use of the "input gain" control.

Tape In: This input allows the output of an individual tape track to be routed to the mixer's input. This selection is accomplished by using the mic/line tape switch, and is utilized for overdubbing, mixdown and ping-ponging tape tracks.

High Frequency EQ: This is a 10 kHz shelving-type equalizer for boosting or cutting high frequencies up to 15 dB.

Low Frequency EQ: This is a 50 Hz shelving-type equalizer for boosting or cutting low frequencies up to 15 dB.

About Shelving Equalizers

The high and low frequency equalization of the AMR 42 utilize a shelving type equalizer circuit. While referring to the EQ graphs, you will see that slight amounts of boost or cut affect only the extreme high or low frequency ranges. If you will refer to Figure #1, you will notice that a 5 dB boost at 50 Hz has little effect at 200 Hz, while a 15 dB boost at 50 Hz will boost 200 Hz by approximately 6 dB. The same is true with the high frequency equalizer in Figure #2, a 5 dB boost at 10 kHz will boost 1 kHz approximately 3 dB, while a 15 dB boost at 10 kHz will boost 1 kHz approximately 6 dB.

With larger amounts of boost or cut, "low frequency" shelving equalizers will affect the frequency ranges "above" as well as "below" the indicated frequency of 50 Hz. Likewise, with larger amounts of boost or cut, "high frequency" shelving equalizers will affect the frequency ranges above and below 10 kHz.

Figure #1 - Low Frequency Shelving Equalizer of the AMR 42

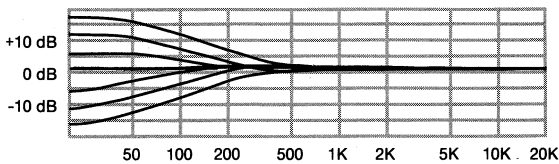
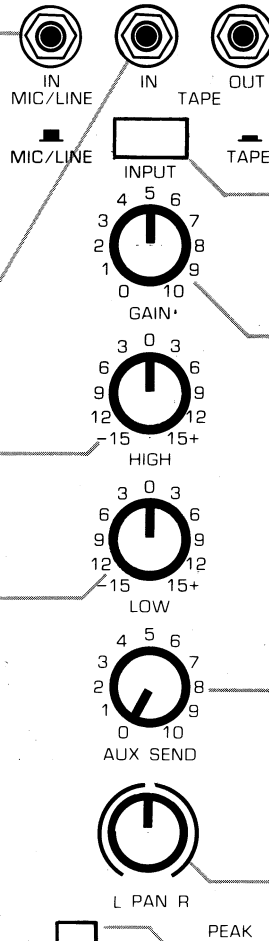
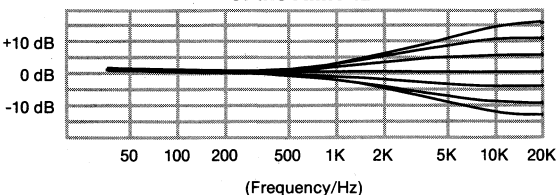

Figure #2 - High Frequency Shelving Equalizer of the AMR 42



Tape Out: This output contains the processed signal of a given tape track after it has been processed by the input (gain, EQ and level), which can then be routed to the input of a multi-track tape recorder.

Mic/Line Tape Switch: Selects either the mic/line (in the up position) or tape (in the down position).

Gain: Adjusts input gain to accommodate the various input signal levels. Clockwise rotation increases sensitivity for weaker signals such as microphone level signals. Counter-clockwise rotation decreases the input sensitivity for stronger line level signals such as tape recorder outputs, electronic keyboards, etc.

Auxiliary Send: A Send Level Control for the use of external reverberation, echo, delay or other signal processing. This sends the signal after the equalizer (post EQ), thereby allowing the signals sent to any signal processing gear to be equalized along with the main signal. The Auxiliary Send Control is also after the Input Fader (post fader) which will allow the Auxiliary Signal Level to be changed by the level settings of the Input Fader.

Pan Control: This control mixes a given input channel to either the left channel, right channel, center (both channels equally), or varying degrees in between.

Peak LED Indicator: This LED indicates an overload condition of a given input. It will flash when the input levels are excessive (0 dBV). It is all right for this indicator to flash on occasion; however, excessive flashing of this indicator warns of an overload condition that will cause audible distortion (+3.5 dBV). You will notice that there is a margin of 3.5 dB between the level that the Peak LED Indicator glows (0 dBV) and the level that will cause audible distortion (+3.5 dBV). The Peak LED Indicator can be a guide in adjusting the input signal levels via the "input gain" control.

Input Channel Fader: Once the Input Channel sensitivity has been adjusted with the Gain Control, the Input Channel Fader is used to make all level adjustments for normal mixing or recording operations.

Auxiliary Returns (L & R): The outputs of effects devices such as reverb, echo, etc. are connected to the Auxiliary Returns (which allow the output signals of such devices to be mixed in with the main signal). The return signal level of the effects devices is controlled by the Auxiliary Return Fader.

A signal line plugged into the Left Auxiliary Return will return the same signal to **both** the left and right channels of the "stereo" (L & R) bus. Likewise, a signal line plugged into the Right Auxiliary Return will return that signal to **both** the left and

right channels of the "stereo" (L & R) bus. If you wish to return a signal to **only** one channel (either L or R), it will be necessary to place an unwired 1/4" phone plug into the unused Auxiliary Return Jack, thereby allowing the signal to return to only the desired channel (L & R).

When connecting stereo signal lines (both L & R channels), you will be placing signal lines via 1/4" phone plugs into each return (L & R), which will allow **each** return to appear in its appropriate channel.

Auxiliary Send Jack: This is the main output of the Auxiliary Send section of the mixer. Its level and signal content is determined by the settings of the Aux Send Controls on each input. This jack provides a signal to be routed to the input of external effects devices such as reverb, echo, delay, etc.

Output Level Indicators: There are two arrays of LED indicators that will provide a visual indication of the AMR 42's left and right master outputs. These twelve-sectioned tricolored arrays are peak level responding, and will indicate signal level fluctuations many times faster than standard VU meters, which will not respond quickly enough to indicate the peak content of a signal.

Graphic Equalizer: This is a stereo, seven-band graphic equalizer with 12 dB of boost or cut that is placed in the output circuit of the AMR 42. Internally, there are two equalizers that share a common set of slide controls. This will allow the user to contour the frequency response of the final mixdown in a symmetrical fashion (a given amount of boost or cut will be identical on both channels). Refer to the graph below to see the affected frequency ranges when using various amounts of boost or cut with this Graphic Equalizer.

Figure #3 - Graphic Equalizer on the AMR 42

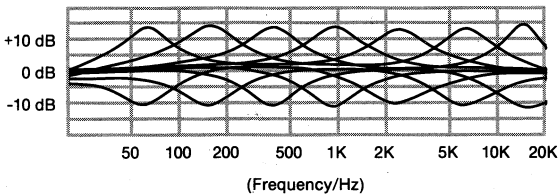

Auxiliary Return Fader: This controls the return signal level of any effects device that is connected to the Auxiliary Returns.

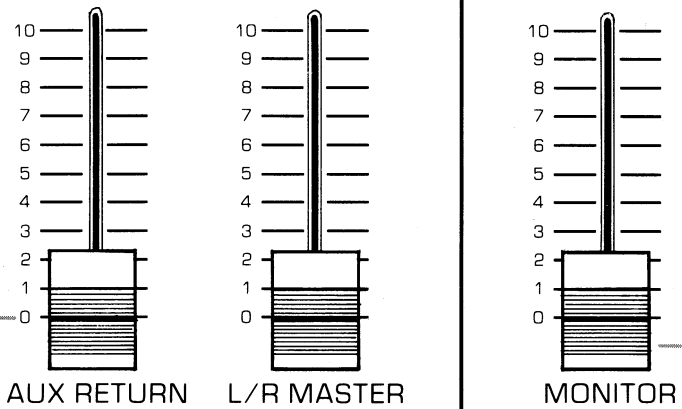
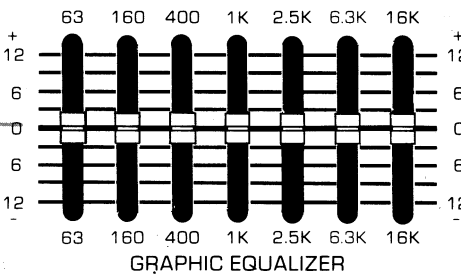
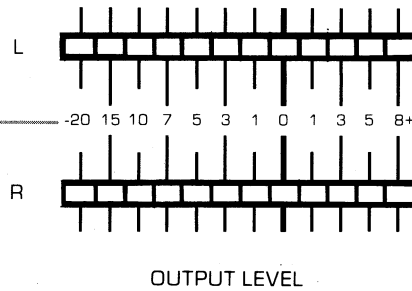
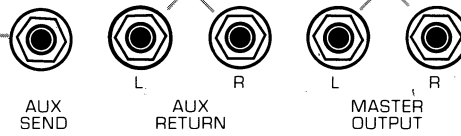

Master Level Controls (L & R): This fader controls the left and right signal levels that appear at the L and R "stereo" outputs.

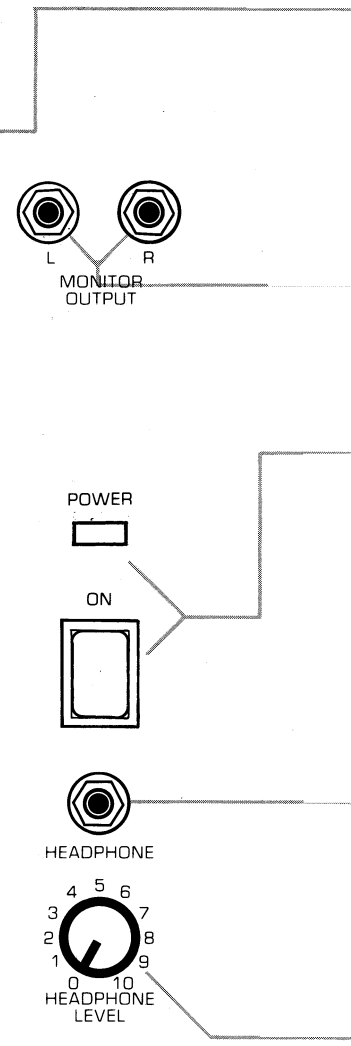

SPECIFICATIONS

Master Outputs (L & R): These two jacks provide the final L & R "stereo" output signal that will be fed to the input of a stereo cassette recorder or a two-track reel-to-reel recorder for the purpose of making your final "stereo" master tape.

Monitor Outputs (L & R): These two outputs contain the same signal information as the Master Outputs. These provide the means of sending the same output signal to a monitor amplifier and speakers for monitoring purposes. The level of the monitor signal is controlled separately by the monitor control fader. The monitor outputs levels have been optimized for driving conventional power amplifiers.

Power Switch and Power On Indicator: This rocker-type switch is used to apply power to the AMR 42. The LED power indicator will indicate when the mixer is on and power applied.

Power Supply: The DC voltage source for the AMR 42 is external and has the entire supply built within the AC power plug. This supply provides 16 volts DC (single ended). CAUTION: Do not use any other supply than the one that is furnished with the AMR 42. Additionally, **do not** attempt to connect 120 VAC from a wall plug to the Power Input Jack on the rear panel of the AMR 42.

Headphone Output: This output has a stereo (tip/ring/sleeve) type jack that will feed any standard stereo headphones. This output can be used for monitoring while overdubbing or to monitor the output of the mixer (if no monitor loudspeakers are being utilized). This output has its own driver amplifier section and will provide 0.3 watts into a pair of 8 ohm headphones.

Headphone Level: This control is used to adjust the signal level of the Headphone Output Jack.

Monitor Level Control: This fader controls the monitor signal level which appears at the Monitor Output Jacks.

Frequency Response	+/- 2 dB 20 Hz - 20 kHz (all EQ flat position)
Equivalent Input Noise	-127 dBV at 40 dB Gain -124 dBV at 30 dB Gain (Mic Input to Channel Output; EQ flat; Slider maximum)
Distortion	Less than .003% THD at 0 dB output
Input Channels	
Input Impedance	50K ohms, microphone 15K ohms, line
Maximum Gain	44 dB
Maximum Input Level (Mic/Line)	0 dBV (LED clip level indicator) +3.5 dBV (maximum level before clipping)
Maximum Channel Output Level	+1.5 dBV (LED clip level indicator) +9.5 dBV (maximum level before clipping)
Output Impedance	1K ohms
Equalizer	
High Frequency	+/-15 dB @ 10 kHz (shelving-type)
Low Frequency	+/-15 dB @ 50 Hz (shelving-type)
Output Section	
Impedance	470 ohms (L&R)
Maximum Output Level	+9.5 dBV (L&R)
Nominal Headroom	10 dB (reference: 0 dBV)
Noise	
Bus	-92 dBV (all channel sliders down; auxiliary return down; graphic sliders set at 0 dB and auxiliary return down)
Nominal	-87.5 dBV (all channels at 30 dB Gain; EQ flat, sliders up; all graphic sliders at 0 dB and auxiliary return down)
Output Level Indicators	0 dB = -10 dBV (internally adjustable from -17 dBV to +9.5 dBV)
Graphic Equalizer	Stereo-type using one set of control sliders +/-12 dB @ 63, 160, 400, 1K, 2.5K, 6.3K and 16 kHz Slider detents at 0 dB
Auxiliary Send and Returns	
Send Output Impedance	1K ohms
Send Maximum Output Level	+9.5 dBV
Return Input Impedance	47K ohms
Return Maximum Input Level	0 dBV
Return Gain	30 dB (maximum)
Monitor Section	
Output Impedance	1K ohms
Nominal Operating Level	0 dBV
Maximum Output Level	+9.5 dBV
Headphone Section	
Output Drive	8 ohms to 300 ohms
Output Power	0.3 watts into 8 ohms
Output Connector	¼" phone (tip/ring/sleeve)
Power Requirements	120 VAC at 50/60 Hz at 15 watts 220 and 240 VAC are available for export markets Meets UL and CSA electrical codes
Dimensions:	17" W x 12.25" H x 1.75" D (431 mm x 311 mm x 44 mm)
Weight:	9 lbs. (4 kg)

Unpacking Your AMR™ 42 Mixer

Enclosed in the shipping carton, you should find the following:

- 1 AMR™ 42 Mixer
- 1 wall mount power supply with cord and connector
- 1 Operating Instructions brochure

Connecting Power to the AMR 42

Connect the wall mount power supply to the mixer by placing the power connector (located at the opposite end of the wall mount transformer cable) into the mating power receptacle on the rear of the mixer. Connect the wall mount power supply to a nearby AC power outlet. It is wise to see that audio signal lines are not near the power transformer in order to prevent hum pickup. Power can then be applied to the mixer by turning on the front panel power switch.

Connecting Signal Lines to the AMR 42 Mixer

There are various system setups in which the AMR 42 mixer may be used, all of which cannot be covered in this operating instruction guide. For a guideline, you will find a line drawing below that indicates where various pieces of equipment may be connected to the AMR 42 mixer.

NOTE: All equipment that is connected to the AMR 42 mixer in the above line drawing is "line level" (nominal -10 dBV), with exception to the microphone signals. Be careful when connecting your mixer to other equipment that you do not connect it to any microphone inputs on such equipment (use line level inputs and outputs only).

Rack Mounting the AMR 42

The AMR 42 may be rack-mounted, if desired, with the accessory rack mount kit. See your AMR dealer and ask for a RM™ 42 rack mount kit.

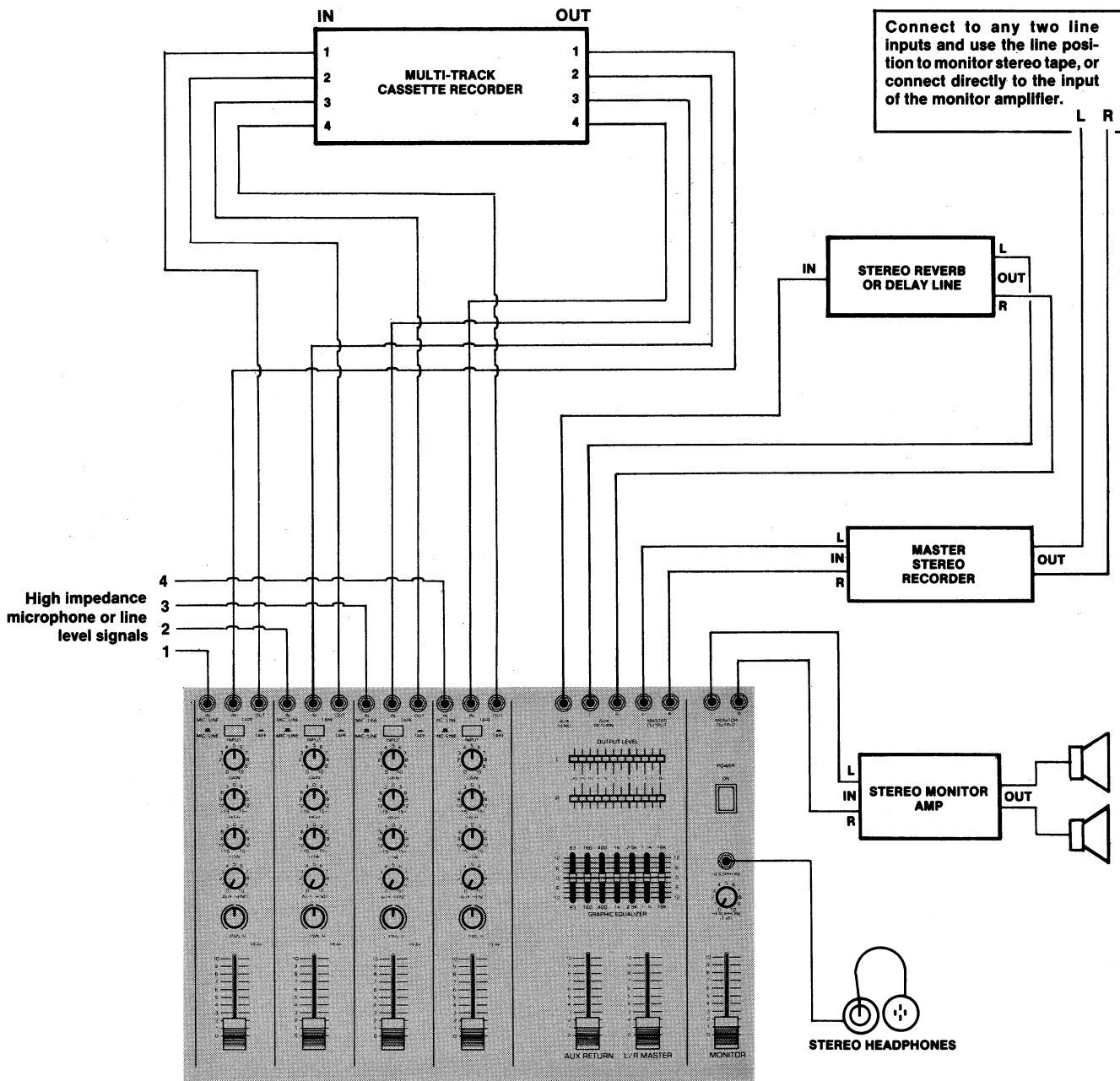

THIS LIMITED WARRANTY VALID ONLY WHEN PURCHASED AND REGISTERED IN THE UNITED STATES OR CANADA. ALL EXPORTED PRODUCTS ARE SUBJECT TO WARRANTY AND SERVICES TO BE SPECIFIED AND PROVIDED BY THE AUTHORIZED DISTRIBUTOR FOR EACH COUNTRY.

Diese Garantie ist nur in den USA und Kanada gültig. Alle Export-Produkte sind der Garantie und dem Service des Importeurs des jeweiligen Landes unterworfen.

Ces clauses de garantie ne sont valables qu'aux Etats-Unis et au Canada. Dans tous les autres pays, les clauses de garantie et de maintenance sont fixées par le distributeur national et assurées par lui selon la législation en vigueur.

Esta garantía es válida solamente cuando el producto es comprado en E.U. continentales o en Canada. Todos los productos que sean comprados en el extranjero, estan sujetos a las garantías y servicio que cada distribuidor autorizado determine y ofrezca en los diferentes países.

ONE-YEAR LIMITED WARRANTY

AMR (Audio Media Research) warrants this product, EXCEPT for covers, footswitches, patchcords, tubes and meters, to be free from defects in material and workmanship for a period of one (1) year from date of purchase PROVIDED, however, that this limited warranty is extended only to the original retail purchaser and is subject to the conditions, exclusions and limitations hereinafter set forth:

AMR 90-DAY LIMITED WARRANTY ON TUBES AND METERS

If this product contains tubes or meters, **AMR** warrants the tubes or meters contained in the product to be free from defects in material and workmanship for a period of ninety (90) days from date of purchase PROVIDED, however, that this limited warranty is extended only to the original retail purchaser and is also subject to the conditions, exclusions and limitations hereinafter set forth.

CONDITIONS, EXCLUSIONS AND LIMITATIONS OF LIMITED WARRANTIES

These limited warranties shall be void and of no effect if:

- The first purchase of the product is for the purpose of resale; or
- The original retail purchase is not made from an AUTHORIZED **AMR** DEALER; or
- The product has been damaged by accident or unreasonable use, neglect, improper service or maintenance, or other causes not arising out of defects in material or workmanship; or
- The serial number affixed to the product is altered, defaced or removed.

In the event of a defect in material and/or workmanship covered by this limited warranty, **AMR** will:

- In the case of tubes or meters, replace the defective component without charge; or
- In other covered cases (i.e., cases involving anything other than covers, footswitches, patchcords, tubes or meters), repair the defect in material or workmanship or replace the product, at **AMR's** option; and provided, however, that in any case all costs of shipping (if necessary) are paid by you, the Purchaser.

THE WARRANTY REGISTRATION CARD SHOULD BE ACCURATELY COMPLETED, MAILED TO AND RECEIVED BY **AMR** WITHIN FOURTEEN (14) DAYS FROM THE DATE OF YOUR PURCHASE.

In order to obtain service under these warranties, you must:

- Bring the defective item to any AUTHORIZED **AMR** DEALER or AUTHORIZED **AMR** SERVICE CENTER and present therewith the PERSONAL WARRANTY IDENTIFICATION CARD along with the ORIGINAL PROOF OF PURCHASE supplied to you by the AUTHORIZED **AMR** DEALER in connection with your purchase from him of this product.

If the DEALER or SERVICE CENTER is unable to provide the necessary warranty service, you will be directed to the nearest other AUTHORIZED **AMR** DEALER or AUTHORIZED **AMR** SERVICE CENTER which can provide such service.

OR

- Ship the defective item, prepaid, to:

AMR NATIONAL SERVICE CENTER
HIGHWAY 503
DECATUR, MS 39327

including therewith a complete, detailed description of the problem, together with your PERSONAL WARRANTY IDENTIFICATION CARD along with a legible copy of the original PROOF OF PURCHASE and a complete return address. Upon **AMR's** receipt of these items:

- If the defect is remedial under these limited warranties and the other terms and conditions expressed herein have been complied with, **AMR** will provide the necessary warranty service to repair or replace the product and will return it, FREIGHT COLLECT, to you, the Purchaser.

AMR's liability to the purchaser for damages from any cause whatsoever and regardless of the form of action, including negligence, is limited to the actual damages up to the greater of \$500.00 or an amount equal to the purchase price of the product that caused the damage or that is the subject of or is directly related to the cause of action. Such purchase price will be that in effect for the specific product when the cause of action arose. This limitation of liability will not apply to claims for personal injury or damage to real property or tangible personal

property allegedly caused by **AMR's** negligence. **AMR** does not assume liability for personal injury or property damage arising out of or caused by a non-**AMR** alteration or attachment, nor does **AMR** assume any responsibility for damage to interconnected non-**AMR** equipment that may result from the normal functioning and maintenance of the **AMR** equipment.

UNDER NO CIRCUMSTANCES WILL **AMR** BE LIABLE FOR ANY LOST PROFITS, LOST SAVINGS, INCIDENTAL DAMAGES OR CONSEQUENTIAL DAMAGES ARISING OUT OF THE USE OR INABILITY TO USE THE PRODUCT, EVEN IF **AMR** HAS BEEN ADVISED OF THE POSSIBILITY OF SUCH DAMAGES.

THESE LIMITED WARRANTIES ARE IN LIEU OF ANY AND ALL WARRANTIES, EXPRESS OR IMPLIED, INCLUDING, BUT NOT LIMITED TO, THE IMPLIED WARRANTIES OF MERCHANTABILITY AND FITNESS FOR A PARTICULAR USE, PROVIDED, HOWEVER, THAT IF THE OTHER TERMS AND CONDITIONS NECESSARY TO THE EXISTENCE OF THE EXPRESS LIMITED WARRANTIES, AS HEREBY STATED, HAVE BEEN COMPLIED WITH, IMPLIED WARRANTIES ARE NOT DISCLAIMED DURING THE APPLICABLE ONE-YEAR OR NINETY-DAY PERIOD FROM DATE OF PURCHASE OF THIS PRODUCT.

SOME STATES DO NOT ALLOW LIMITATION ON HOW LONG AN IMPLIED WARRANTY LASTS OR THE EXCLUSION OR LIMITATION OF INCIDENTAL OR CONSEQUENTIAL DAMAGES, SO THE ABOVE LIMITATIONS OR EXCLUSIONS MAY NOT APPLY TO YOU. THESE LIMITED WARRANTIES GIVE YOU SPECIFIC LEGAL RIGHTS, AND YOU MAY ALSO HAVE OTHER RIGHTS WHICH MAY VARY FROM STATE TO STATE.

THESE LIMITED WARRANTIES ARE THE ONLY EXPRESS WARRANTIES ON THIS PRODUCT; AND NO OTHER STATEMENT, REPRESENTATION, WARRANTY OR AGREEMENT BY ANY PERSON SHALL BE VALID OR BINDING UPON **AMR**.

In the event of any modification or disclaimer of express or implied warranties, or any limitation of remedies, contained herein conflicts with applicable law, then such modification, disclaimer or limitation, as the case may be, shall be deemed to be modified to the extent necessary to comply with such law.

Your remedies for breach of these warranties are limited to those remedies provided herein and **AMR** gives this limited warranty only with respect to equipment purchased in the United States of America and Canada.

INSTRUCTIONS — WARRANTY REGISTRATION CARD

1. Mail the completed WARRANTY REGISTRATION CARD to:

AUDIO MEDIA RESEARCH
HIGHWAY 503
DECATUR, MS 39327

- a. Keep the PERSONAL WARRANTY ID CARD along with your PROOF OF PURCHASE. In the event warranty service is required during the warranty period, you will need these documents. **There will be no other identification card issued by AMR.**
 - b. Defaced, mutilated or altered cards will not be honored.
2. IMPORTANCE OF WARRANTY REGISTRATION CARDS AND NOTIFICATION OF CHANGES OF ADDRESS:
 - a. Completion and mailing of WARRANTY REGISTRATION CARDS - Should notification become necessary for any condition that may require correction, the REGISTRATION CARD will help insure that you are contacted and properly notified.
 - b. Notice of address changes - If you move from the address shown on the WARRANTY REGISTRATION CARD, you should notify **AMR** of the change of address so as to facilitate your receipt of any bulletins or other forms of notification which may become necessary in connection with any condition that may require dissemination of information or correction.
 3. Any correspondence with the factory concerning this product should include the serial number of the item(s).

RETAIN YOUR PROOF OF PURCHASE

DANGER

Exposure to extremely high noise levels may cause a permanent hearing loss. Individuals vary considerably in susceptibility to noise induced hearing loss, but nearly everyone will lose some hearing if exposed to sufficiently intense noise for a sufficient time.

The U.S. Government's Occupational Safety and Health Administration (OSHA) has specified the following permissible noise level exposures:

Duration Per Day in Hours	Sound Level dBA, Slow Response
8	90
6	92
4	95
3	97
2	100
1 1/2	102
1	105
1/2	110
1/4 or less	115

According to OSHA, any exposure in excess of the above permissible limits could result in some hearing loss. Ear plugs or protectors in the ear canals or over the ears must be worn when operating this amplification system in order to prevent a permanent hearing loss if exposure is in excess of the limits as set forth above. To insure against potentially dangerous exposure to high sound pressure levels, it is recommended that all persons exposed to equipment capable of producing high sound pressure levels such as this amplification system be protected by hearing protectors while this unit is in operation.

CAUTION

This mixer has been designed and constructed to provide adequate power reserve for recording or reproducing modern music which may require occasional peak power. To handle occasional peak power, adequate power "headroom" has been designed into this system. Extended operation at absolute maximum amplifier power levels is not recommended since this could damage the associated loudspeaker system. Please be aware that maximum power can be obtained with very low settings of the gain controls if the input signal is very strong.

1. Read all safety and operating instructions before using this product.
2. All safety and operating instructions should be retained for future reference.
3. Obey all cautions in the operating instructions and on the back of the unit.
4. All operating instructions should be followed.
5. This product should not be used near water; i.e., a bathtub, sink, swimming pool, wet basement, etc.
6. This product should be located so that its position does not interfere with its proper ventilation. It should not be placed flat against a wall or placed in a built-in enclosure that will impede the flow of cooling air.

7. This product should not be placed near a source of heat such as a stove, heater, radiator or another heat-producing amplifier.
8. Connect only to a power source of the type marked on the unit adjacent to the power supply cord.
9. Never break off the ground pin on the power supply cord. For more information on grounding, write for our free booklet, "Shock Hazard and Grounding."
10. Power supply cords should always be handled carefully. Never walk or place equipment on power supply cords. Periodically check cords for cuts or signs of stress, especially at the plug and the point where the cord exits the unit.
11. The power supply cord should be unplugged when the unit is to be

unused for long periods of time.

12. Metal parts can be cleaned with a damp rag. The vinyl covering parts on some units can be cleaned with a damp rag or an ammonia-based household cleaner if necessary.
13. Care should be taken so that objects do not fall and liquids are not applied into the unit through the ventilation holes or any other openings.
14. This unit should be checked by a qualified service technician if:
 - A. The power supply cord or plug has been damaged;
 - B. Anything has fallen or been spilled into the unit;
 - C. The unit does not operate correctly; or
 - D. The unit has been dropped or the enclosure damaged.
15. The user should not attempt to service this equipment. All service work should be done by a qualified service technician.

AMRTM

AUDIO MEDIA RESEARCH ROUTE 2 HWY 503 DECATUR, MS 39327

#80300534 ©1/86
Printed in U.S.A.